

SILVERLINE

Derwent 90cm Ceiling Hood



Installation & User Instructions

Please read these instructions carefully before installing and operating this appliance

Contents

1. Introduction	3
2. Health and Safety	3-4
3. Installation	4-9
3.1 Assembly Instructions	4-7
3.2 Ducting Options	5
3.3 Motor Options	5-6
3.4 Electrical Wiring	6-8
3.4.1 Electrical Wiring Diagram	7
3.4.2 Controls	8
4. Use & Maintenance	8
4.1 Cleaning the Metal Filters	8
4.2 Cleaning the Hood	8
5. Technical Data	8
6. Dimensions	9-11
6.1 Derwent 90cm Ceiling Hood	9-10
6.2 1240 T1 Motor	10
6.3 1250 T2 Motor	11

1. Introduction

Dear Customer,



We wish to thank you for choosing this Silverline cooker hood. In order to get the best performance from your appliance we recommend that you read this booklet carefully before operating the appliance for the first time.

Revisions to the publication

In order to improve the product, to keep this publication up to date the manufacturer reserves the right to make modification without any advance notice. Any reproduction, even in part, of this manual without the consent of the manufacturer is prohibited.

Care of the manual and how to consult it

- Take good care of this manual and keep it in a place which can be easily and quickly reached.
- If this manual should be lost or destroyed, or if it is in poor condition, ask for a copy from your retailer, providing product identification data.
- Information which is essential or that requires special attention is shown in bold text.

	ATTENTION This warning sign indicates that the message to which it refers should be carefully read and understood, because failure to comply with what these notices say can cause serious damage to the extractor and put the user's safety at risk.
	INFORMATION This symbol is used to highlight information which is important for proper extractor operation. Failure to comply with these provisions will compromise use of the boiler and its operation will not be satisfactory.
	MANUAL Indicates that you should carefully read this manual or the related instructions.

2. Health and Safety



- **Installation of the cooker hood, making electrical connections, checking its operation and maintenance are all tasks which should be**

carried out by qualified and authorised personnel.

- **Install the cooker hood in accordance with the regulations in force in your local area, region and country.**
- For the correct use of the appliance and to prevent accidents, the instructions given in this booklet must always be followed.
- Before beginning any operation, the user, or whoever is preparing to operate on the appliance, must have read and understood the entire contents of this instruction booklet.
- All responsibility for improper use is taken entirely by the user and as such relieves Silverline of any civil or criminal responsibility.
- In view of the fact that it is an electrical appliance, do not touch the appliance with wet hands.
- Before carrying out any cleaning or maintenance operation, make sure in advance that the appliance is isolated from the mains electricity supply.
- Incorrect installation or faulty maintenance (not conforming to the requirements set out in this booklet) can cause harm to people, animals or property. In such cases Silverline is absolved from any civil or criminal responsibility.

This product complies with EU Directive EU2002/96/EC.

The crossed bin symbol on the appliance indicates that the product, at the end of its life, must be disposed of separately from domestic waste, either by taking it to a separate waste disposal site for electric and electronic appliances or by returning it to your dealer when you buy another similar appliance. The user is responsible for taking the appliance to a special waste disposal site at the end of its life. If the disused appliance is collected correctly as separate waste, it can be recycled, treated and disposed of ecologically.

WARNINGS:

- This appliance can be used by children aged from 8 years and above and persons with reduced physical, sensory or mental capabilities, or lack of experience and knowledge if they have been given supervision or instruction concerning use of the appliance in a safe way and understand the hazards involved.
- Children shall not play with the appliance. Cleaning and user maintenance shall not be made by children without supervision.

- Before cleaning or performing any periodic or urgent maintenance to the hood, isolate the mains supply and turn the main switch off.
- Do not connect the hood to any piping used for combustion appliances, such as burners, boilers or fire places.
- Check that the main power supply corresponds to the voltage required by the hood, which is given on the silver label stuck inside the hood. Ensure that the electric system is correctly earthed and that the earth discharge works correctly.
- When cooking do not use any materials that could form high or unusual flames. Oil that has been used twice and fats are very dangerous and could easily catch fire. Do not prepare flambé dishes under the hood.
- Once the specialised technician has completed the installation of the hood equipped with a remote motor, all the leads, connectors, ground connections and the remote motor must not be accessible to the user. Only the installer is granted access by removing screwed on panel.
- Respect local legislation and regulations issued by the relative authorities regarding the exhaust air when the suction is operating. Failure to respect and perform all maintenance and cleaning operations described in this handbook could cause a fire hazard.



ATTENTION: Accessible parts may become hot when the hood is used with cooking appliance.

3. Installation

The minimum safety distance between the bottom of the hood and the top of the cooking hob must be 650mm, smaller distances must be previously authorised by the manufacturer. The maximum is 1.6m.

When the suction function is operating i.e. exhausting the filtered air on the outside, a suitable compensation system must be used according to current standards in force. The diameter of the fume exhaust pipe must be the same or greater than the diameter of the hood pipe union.

There must be sufficient ventilation in the room where the hood is installed, to allow simultaneous use of other appliances that use gas or other fuels.

3.1 Assembly Instructions

Attention: Before proceeding with the installation, make sure that the screws and the anchors supplied, are suitable for the type of wall/ceiling the hood will be fixed to.

To assemble the hood use the accessories that are supplied and follow the instructions given in the enclosed hand book.

Hanger Hooks

The Derwent has 4 hanger hooks at each corner to secure the hood to the ceiling (**Fig 1**).

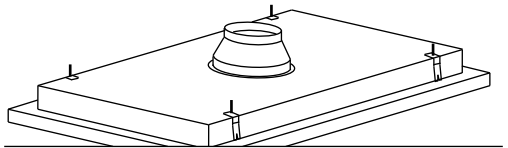

Fig 1

Cut-out dimensions

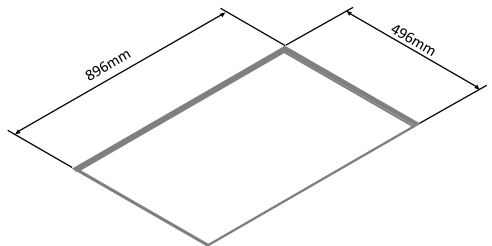

Fig 2

Ducting Dimensions

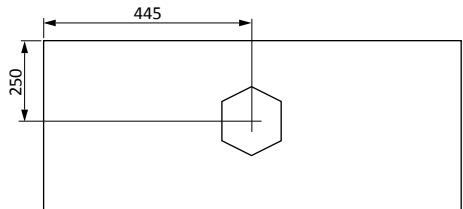

Fig 3

1. Pull down on the glass panel to reveal the grease filters (Fig 4).

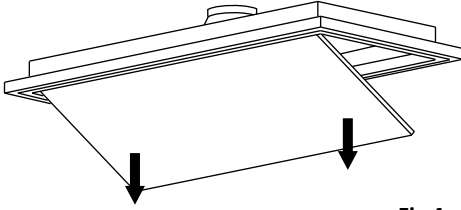

Fig 4

2. Remove the grease filters and place the 200/150mm ducting adapter to the back of the hood (Fig 5).

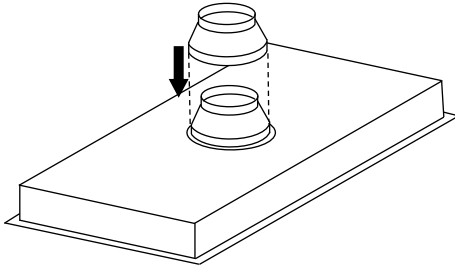

Fig 5

3. Put the Derwent up into the ceiling (Fig 6).

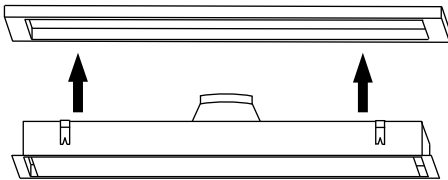

Fig 6

4. Make sure the hanger hooks are in position and tighten the screws to clamp the hood to the ceiling (Fig 7).

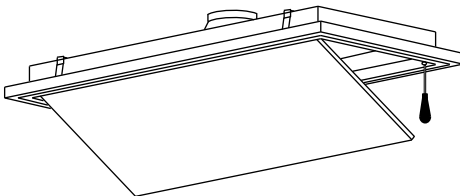

Fig 7

3.2 Ducting Options

The Derwent is ducted using either rigid ducting from the back of the hood (Fig 7 & Fig 8).

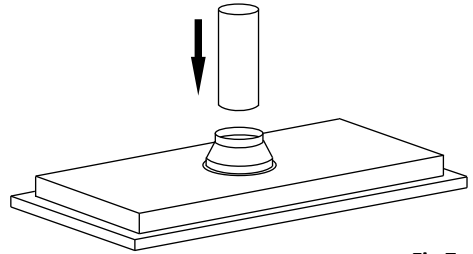

Fig 7

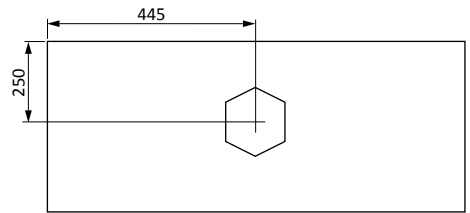

Fig 8

3.3 Motor Options

The Derwent ceiling hood can be fitted with either the 1240 T1 750m³/h motor or the 1250 T2 1400m³/h motor. This can be installed anywhere along the ducting but no more than 6m away.

1. The motor is fixed to the wall using the L brackets supplied. Screw the motor to the L brackets and attach through A & B points to the wall (Fig 9).

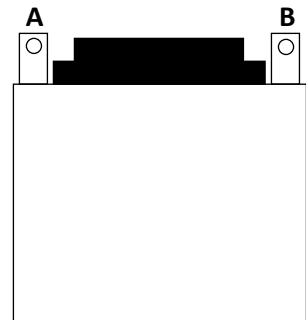

Fig 9

2. Mount the rigid ducting onto the plastic connector of the hood (Fig 10).

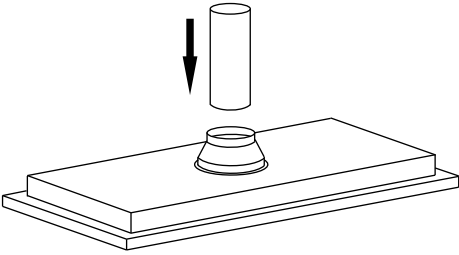

Fig 10

3. Install the ducting work up to the air inlet of the motor (Fig 11).

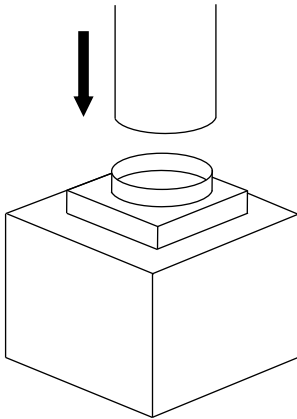

Fig 11

4. Install ducting between the air outlet on the motor and the external vent.

provide a device that ensures disconnection from the electrical mains, with an opening distance of the contacts that allows the complete disconnection under the conditions of overvoltage category III, in accordance with the rules of installation. The plug or Omni polar switch must be accessible when the unit is installed.

If the power cord is damaged, it must be replaced by a special cord or assembly available from the manufacturer or its service agent. The cable must be of type H05VV-F 3 x 0.75mm² minimum cross-section.

The manufacturer declines all responsibility if the current accident prevention standards in force are not respected, which are needed for the wiring system to operate correctly.

3.4 Electrical Wiring

The electrical wiring must be performed by a specialised electrician fully respecting current standards and legislation in force. **Check that the power supply corresponds to the voltage requested by the hood, which is given on the silver label stuck inside the hood.** Ensure that the wiring system conforms to current standards and the earth discharge works efficiently. Pay special attention to the hood power cable, ensure that it does not pass through any holes without a cable clamp. For direct connection to the electrical mains it is necessary to

3.4.1 Electrical Wiring Diagram

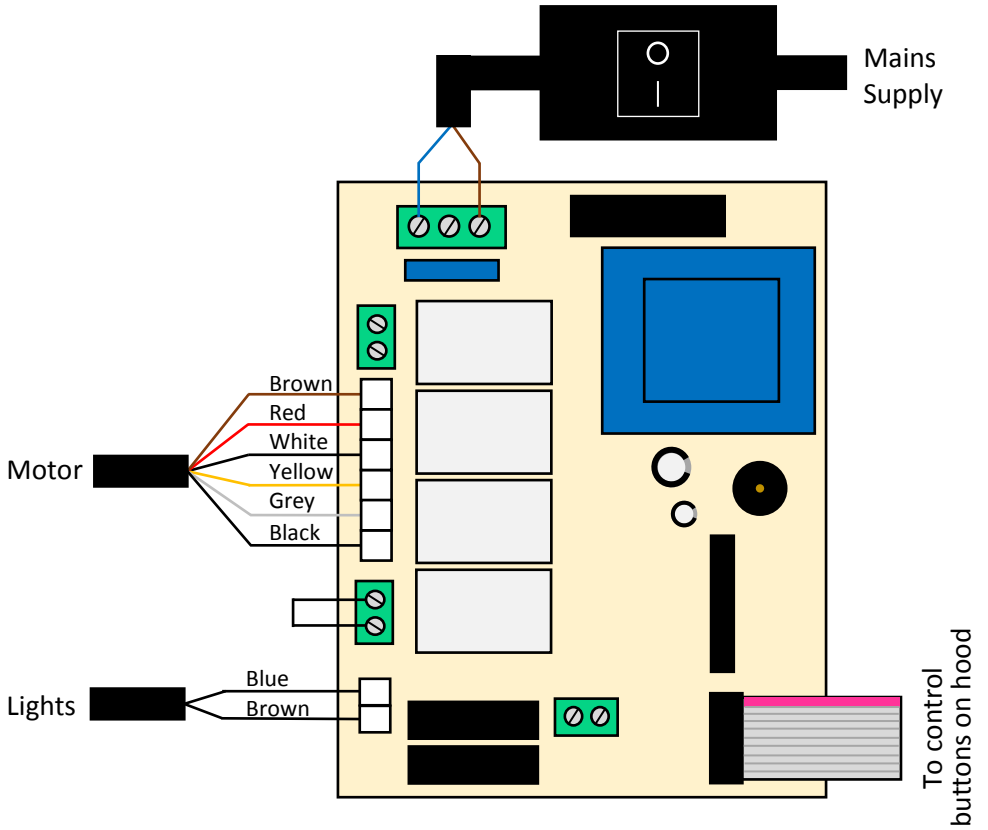

3.4.2 Controls

The Derwent ceiling hood is controlled by remote control. This allows the user to control the hoods on/off functions, lights and the 4 motor speeds.

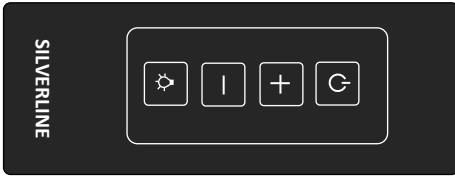

Fig 12

- ⏻ Turns the hood on/off at motor speed 2.
- +
- Decreases motor speed.
- 🔄 Turns lights on/off.

4. Use & Maintenance

Before beginning any sort of cleaning or maintenance work, turn the power off to the hood by turning the main switch to 0 (OFF).

4.1 Cleaning the Metal Filters

The metal filters fitted in the hood should be washed every 2-3 months, depending on how much the hood is used, using hot water and a liquid detergent that is not too aggressive.

The metal filters can be removed by the special handle, unhooking the front part of the filter and pulling it downwards (Fig 13).

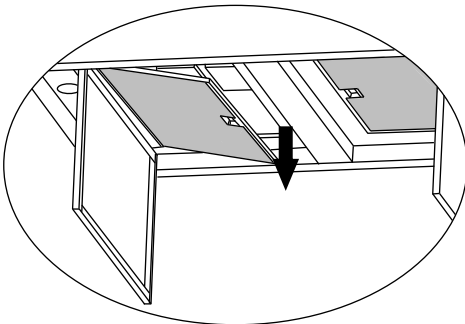

Fig 13

4.2 Cleaning the Hood

The surfaces of the hood should be cleaned frequently, to avoid the risk of having to remove built up and encrusted deposits and stains.

For painted or copper plated hoods just a soft cloth with warm water and a neutral detergent. Do not pour the detergent directly onto the hood or use powdery or abrasive products.

For stainless steel hood, use special products and cloths for satin finish stainless steel (not abrasive, corrosive detergents or detergents containing chloride), ensuring to clean in the same direction as the satin finish.

Do not use aggressive products, chemical solvents or derivatives of oil distillates that could leave oily traces which could cause oxidation and polymerisation.

The manufacturer accepts no responsibility for damage to the surface of the hood due to failure to respect these instructions.

5. Technical Data

Derwent 90cm with 1240 T1 Motor	
Control	Remote Control
Colour/finish	Black Glass
Lighting	19w LED
Airflow (m ³ /h)	700
Noise (db)	54-59
Power (W)	229
Voltage (V)	230
Outlet Width (mm)	150
Weight (kg)	20

Derwent 90cm with 1250 T2 Motor	
Control	Remote Control
Colour/finish	Black Glass
Lighting	19w LED
Airflow (m ³ /h)	1400
Noise (db)	54-69
Power (W)	439
Voltage (V)	230
Outlet Width (mm)	150
Weight (kg)	20

6. Dimensions

6.1 Derwent 90cm Ceiling Hood

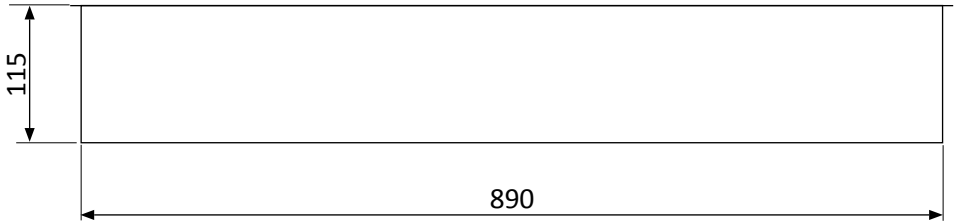
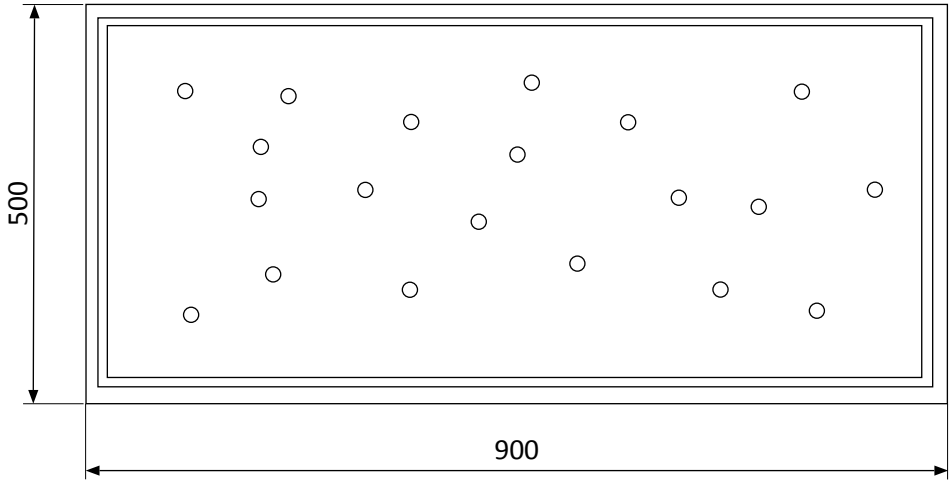

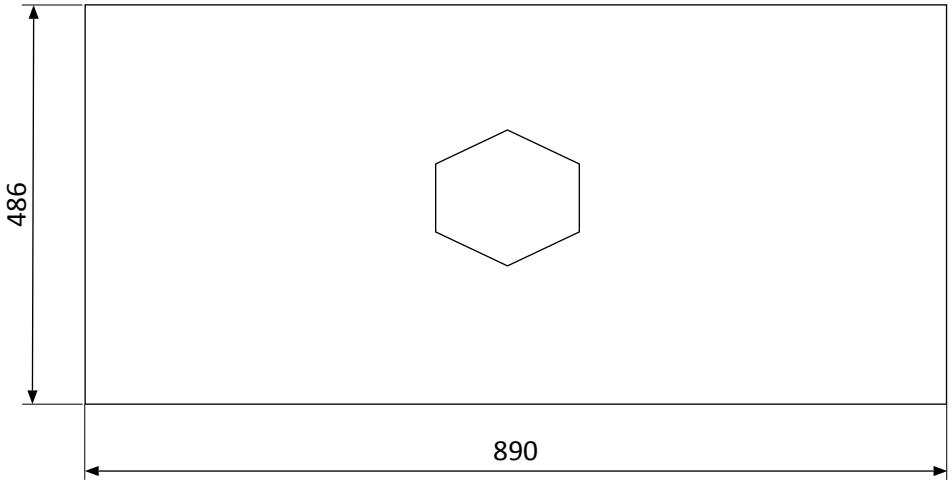

6.2 1240 T1 Motor

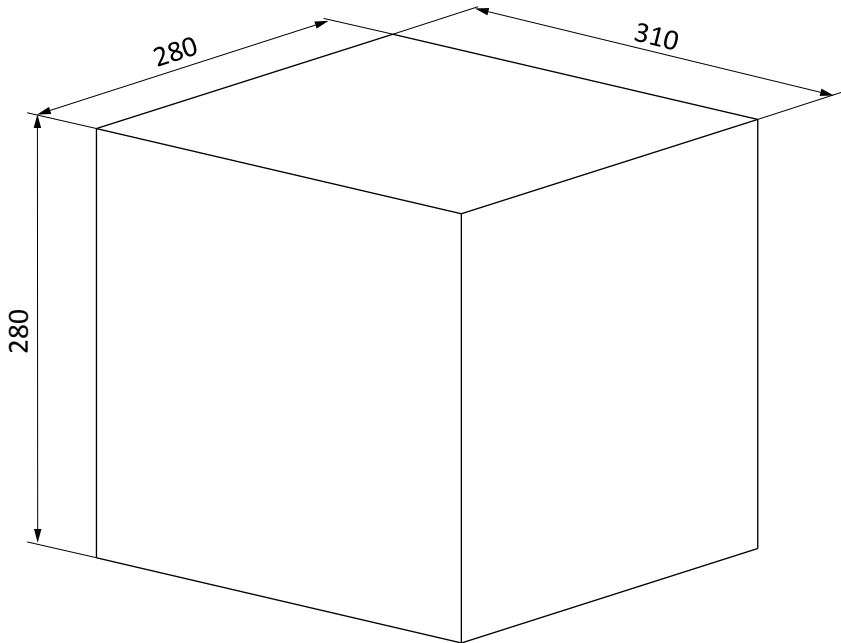

6.3 1250 T2 Motor

